



INSTALLATION AND SERVICE INSTRUCTIONS

S9051E 4 INCH REMODEL HOUSING

CAUTION

RISK OF SHOCK

Disconnect power at fuse or circuit breaker before installing or servicing.

CAUTION

RISK OF FIRE

Not for use in insulated ceilings. Keep combustible materials 3" (76mm) away from fixture.

Installation and servicing to be performed only by qualified personnel. Must be installed in accordance with authority having jurisdiction.

Do not energize the circuit until the trim / lamp module is properly installed.

Remodel Housing Installation

- Step 1:** Using template provided carefully scribe a circle in desired location.
- Step 2:** Carefully cut Ø4" (100mm) hole in ceiling.
- Step 3:** Remove junction box cover.
- Step 4:** Connect supply wires to lead wires (per wiring diagram).
- Step 5:** Replace junction box cover.
- Step 6:** Insert fixture into opening and secure trim with a quarter turn.

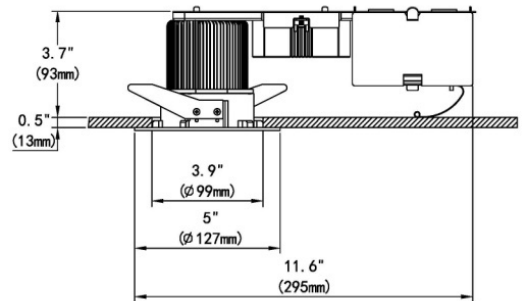
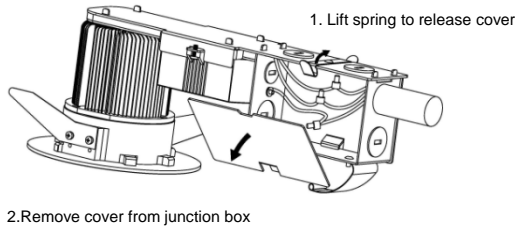
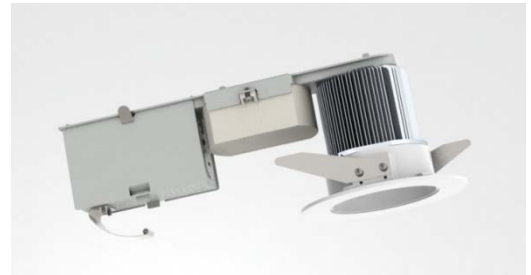

WIRING DIAGRAM

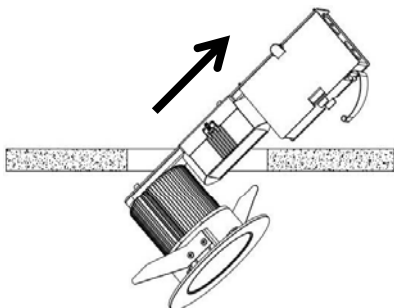
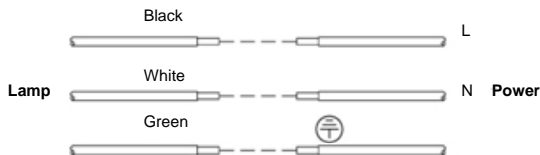

Specifications	
MODEL	S9051E15 / S9051E21
Rated Voltage	120V/60Hz
Rated Power	15W/21W
Rated Line Current	0.125A/0.170A
LED Current	700mA
Dimmable	Yes
SUITABLE FOR DAMP LOCATIONS	Yes



INSTALLATION AND SERVICE INSTRUCTIONS

S9051E 4 INCH REMODEL HOUSING

Driver Replacement

1. REMOVE THE LAMP

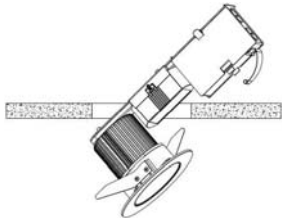

2. UNCLENCH THE FOUR MARKED TABS

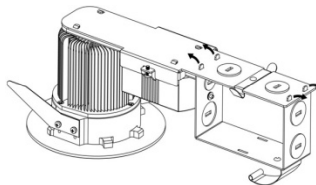

3. REMOVE THE JUNCTION BOX

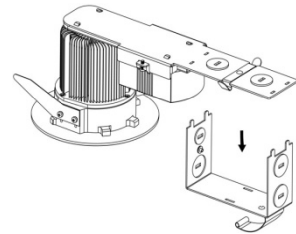

4. UNCLENCH THE FOUR MARKED TABS

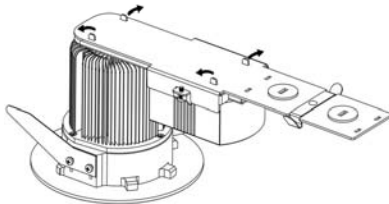

5. REMOVE THE PLATE

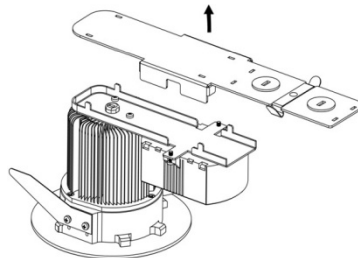

6. REMOVE THE WIRE CONNECTORS

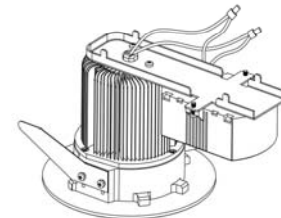

7. REMOVE THE TWO SCREWS AND REPLACE DRIVER

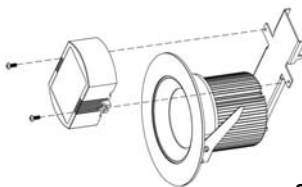

EXTERNAL WIRING DIAGRAM

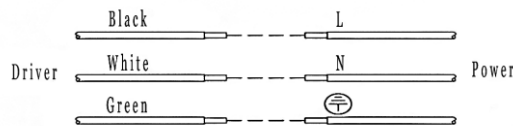

INTERNAL WIRING DIAGRAM

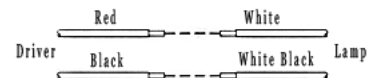

8. RE-ASSEMBLE BY FOLLOWING STEPS IN REVERSE ORDER

WARRANTY TERMS

- We guarantee the lamp for 5 years and the driver 3 years from the date of purchase. Parts or Product defective in material or workmanship will be repaired or replaced without cost when warranty conditions are met. The warranty does not apply to normal wear and tear or cosmetic deterioration.
- To qualify for the warranty, register the purchase by sending this form and copy of the purchase receipt to the address or email shown below. The warranty is extended to the original purchaser only.
- The warranty is void if: warranty period exceeded; warranty form and copy of purchase receipt not received; installation and/or service performed by unqualified personnel or not in accordance with instructions; non-standard operating conditions; damage caused by fire, flood, earthquake, power spikes/interruptions and other natural or man-made disasters.
- ORR Lighting™ reserves the right to review and approve all warranty claims. ORR Lighting™ will not accept charges of any kind without prior written authorization. No charges for labour will be accepted. Orr Lighting™ liability limited to product repair or replacement only with maximum value limited to the original purchase price. No other express or implied warranties applicable.
- Procedure for claims: Contact Orr Lighting™ with details of claim and supporting documentation. Orr Lighting™ will review claim and issue an RMA (Returned Merchandise Authorization) number. Goods returned without an RMA will not be accepted. Products returned with an RMA must be properly packaged to avoid damage in shipping and sent freight prepaid. Orr Lighting™ will inspect returned product with an RMA, and if covered under warranty conditions will send repaired item or replacements to customer prepaid. Contact information: ORR Lighting™ c/o Can-Bramar Ltd., 1939 Leslie St., Toronto, ON Canada M3B 2M3 info@can-bramar.com Ph: 416 251-3232.

REGISTRATION FORM

Name of registrant/purchaser _____

Address _____

Email address _____

Phone _____

Date of Purchase _____

Place of Purchase _____

Copy of Purchase Receipt attached